

# User Manual

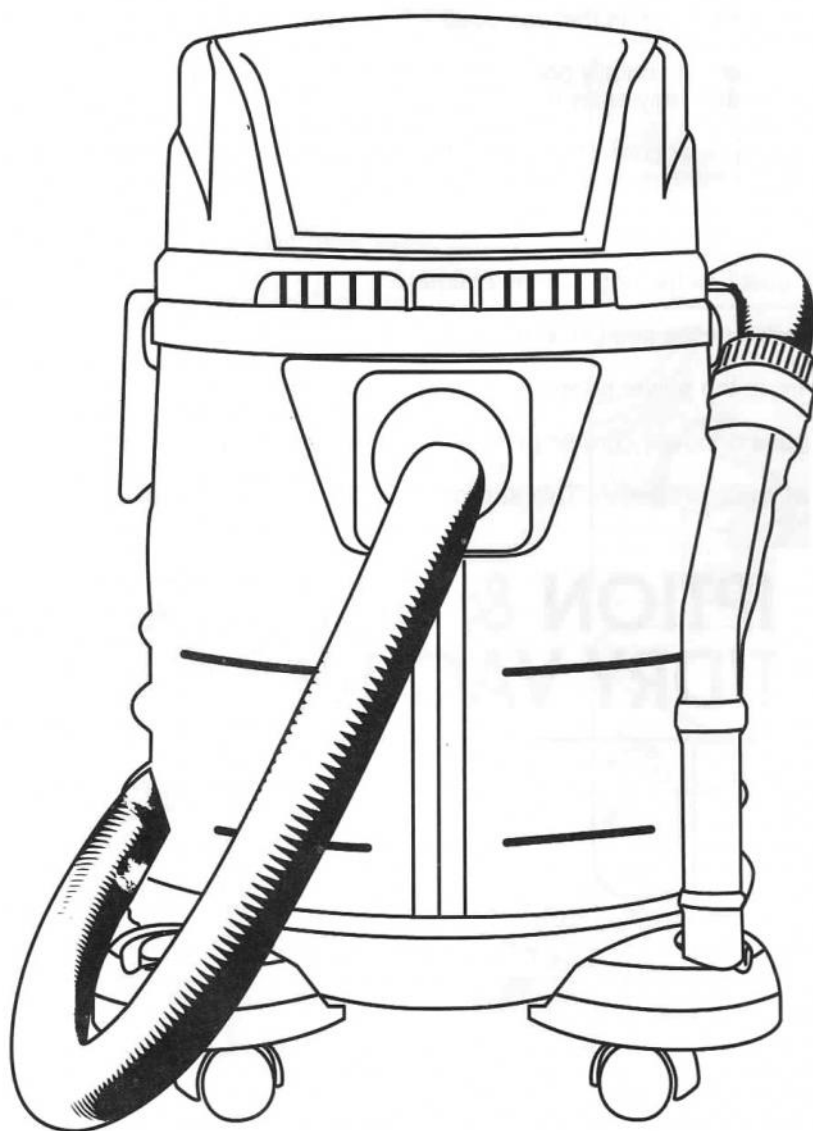

## 3 in 1 Vacuum Cleaner

**WET • DRY • BLOW**

PLEASE READ INSTRUCTIONS CAREFULLY BEFORE USE & RETAIN FOR FUTURE REFERENCE

# OPERATING INSTRUCTIONS

## PLEASE READ CAREFULLY BEFORE USE

1. This appliance is strictly for indoor use only and not for industrial use.
2. Ensure the voltage at the power outlet corresponds to the voltage indicated on the rating label.
3. If the power cord is damaged, switch off immediately and it must be replaced by the manufacturer or authorized service technician.
4. Never suck up asbestos or asbestos dust or anything that is burning or smouldering.
5. Never suck up flammable substances and do not suck up ashes unless they are cold. Do not use the appliance in rooms with explosive vapours (petrol, thinners, solvents).
6. Never suck up inflammable or corrosive liquids such as petrol or other volatile substances.
7. Avoid sucking up sharp objects or objects that can obstruct the hose.
8. Always use the vacuum cleaner horizontally positioned. Never operate it on a slanted surface or hang it upside down. Otherwise the water may enter the motor to damage it.
9. Do not pull, lift or carry by the power cord. Do not use the cord as handle. Avoid closing the door on the cord or yank the cord around or against sharp edges or corners.
10. Do not use the appliance without the filter in place.
11. Never leave refuse in the dust box for long periods of time.
12. Do not handle the plug, switch or the appliance with wet hands.
13. Always remove the plug from the power socket in case of any malfunction, and after use and before cleaning.
14. Do not position the appliance or power cord on or near hot surfaces or near open flames.
15. Keep the appliance out of children's reach. This appliance should only be used by adults.

## DESCRIPTION & GENERAL ASSEMBLY OF WET/DRY VACUUM CLEANER

- A. Motor head
- B. Switch
- C. Float, prevents water from entering motor when is tank full.
- D. Polyester filter, removable for liquid suction.
- E. Hand lock
- F. Suction inlet.
- G. Tank
- H. Flexible hose
- I. Extension Wands
- J. Ellipse Brush
- K. Crevice tool
- L. Master Nozzle (for dry)
- M. Squeegee Nozzle (for wet)

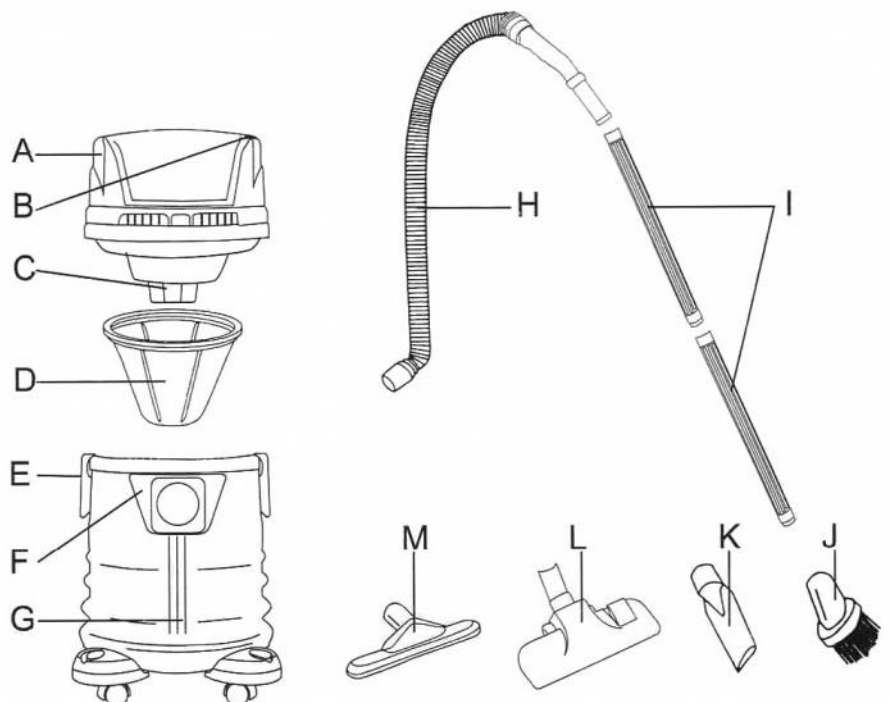

## ATTENTION

TO ENSURE THE EFFICIENT PERFORMANCE OF THE MACHINE, CLEAN THE POLYESTER FILTER AND AFTER EACH USE

## THE VACUUM CLEANER IS DESIGNED FOR:

- 1 Dry vacuum suction of dust.
2. Wet vacuum suction of water based liquids.
3. Blow vacuuming can be useful for dusting out the garage or workshop.

## DRY VACUUMING

- ◆ Insert the cloth filter bag in the tank. (Fig. 1)
- ◆ Assemble the motor head on tank and lock it manually. (Fig. 3)
- ◆ Connect the flexible hose to the suction inlet. (Fig. 4)
- ◆ Connect the wand and the extensions to the other side of flexible hose. (Fig. 5)
- ◆ Select & connect the most suitable accessory. (Fig. 6).
- ◆ Connect the plug to power outlet and switch on the power. (Fig. 7)
- ◆ Uses of the crevice tool. (Fig. 8)
- ◆ Uses of the Ellipse Brush. (Fig. 9)
- ◆ Uses of the Squeegee Nozzle for floor cleaning (Fig. 10)
- ◆ Uses of the Master Nozzle for carpet tool. (Fig. 11)

## WET VACUUMING

- ◆ Remove the cloth filter bag. (Fig. 2)
- ◆ Assemble the motor head on tank and lock it manually. (Fig. 3)
- ◆ Connect the flexible hose to the suction inlet. (Fig. 4)
- ◆ Connect the wand and the extensions to the other side of the flexible hose. (Fig. 5)
- ◆ Connect the Squeegee Nozzle. (Fig. 6)
- ◆ Connect the plug to power outlet and switch on the power. (Fig. 7)
- ◆ Uses of the Squeegee Nozzle. (Fig. 12)

## BLOW VACUUMING

- ◆ Empty and clean the tank.
- ◆ To remove Blow Cover. (Fig. 13)
- ◆ Fit the hose directly into the exhaust opening. (Fig. 14)

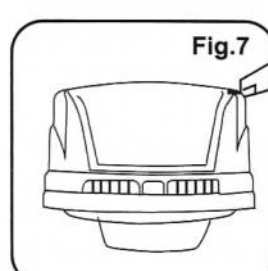
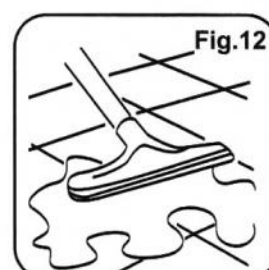
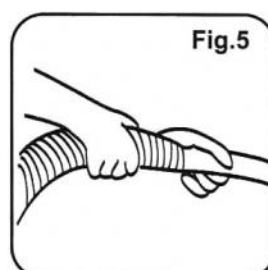
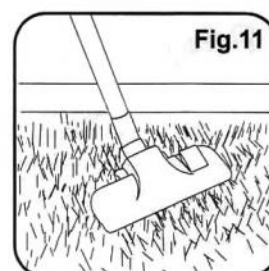
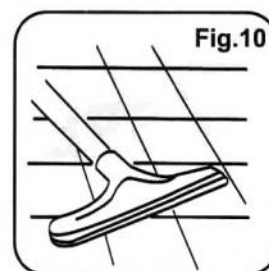
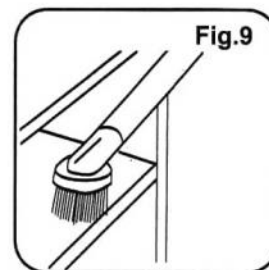
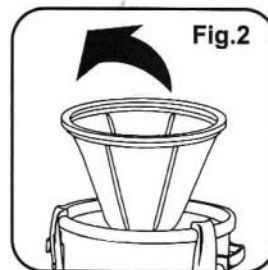
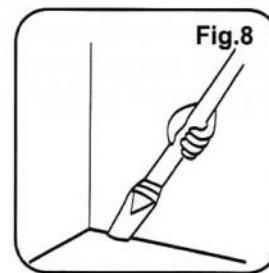

# TROUBLESHOOTING

**If a problem occurs always switch off the unit immediately**

**1 Motor does not operate**

- Ensure unit is plugged in correctly and switched on.

**2. Suction power is reduced or motor operate but weak suction power**

The maximum level of dust or water collection has reached the limit. Press the ON/OFF button, disconnect the power cord from the power outlet and empty tank.

Check and clear any blockages within the system or accessory.

Ensure the filter is clean and not damaged in any way.

**3. Heat from appliance**

- Heat generated from appliance is normal.

# SPECIFICATIONS

Rated Voltage	220 ~ 240V 50/60Hz
Power Consumption	1800W
Max Vacuity Degree	21Kpa
Max Wind Quantity	130Q,CFM

*\* No responsibility is accepted for damage resulting from improper or non-compliance with the instructions.*