

HESSTAR

Instruction manual

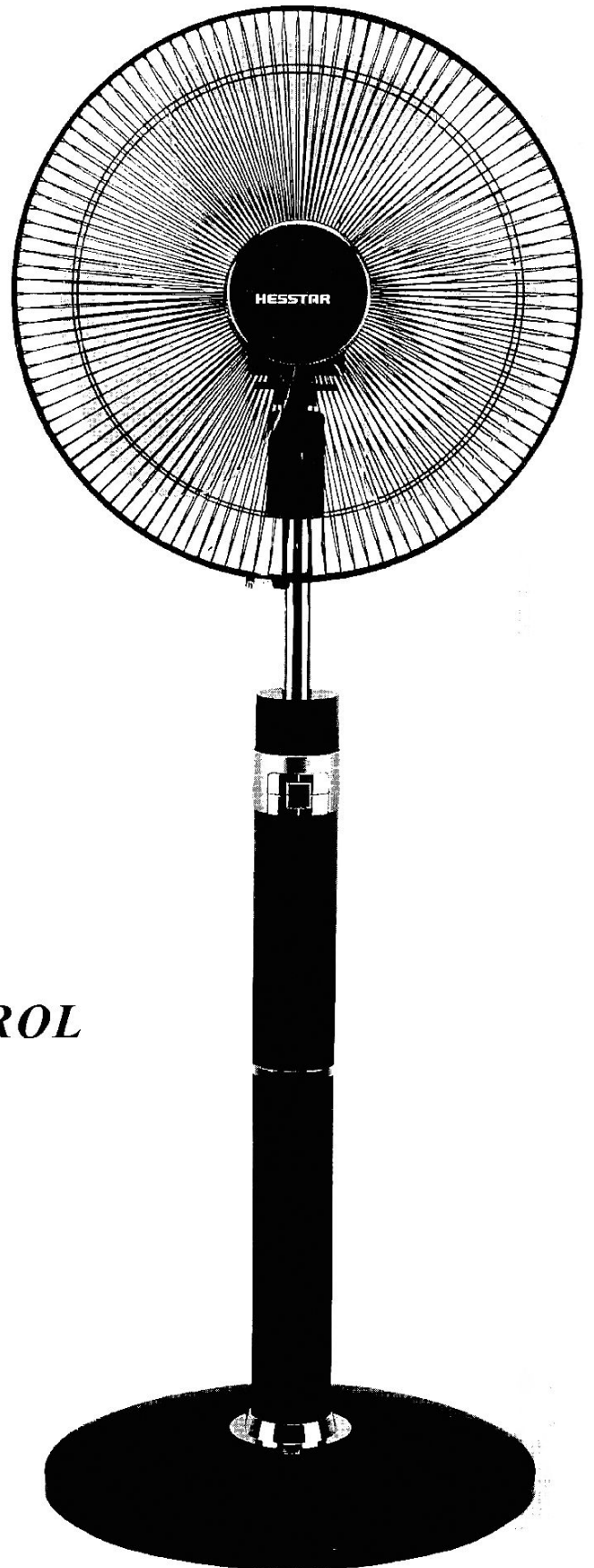

*16"STAND FAN
WITH REMOTE CONTROL*

Before using this unit, please read the instructions completely.

HF-816RS

Product Parts

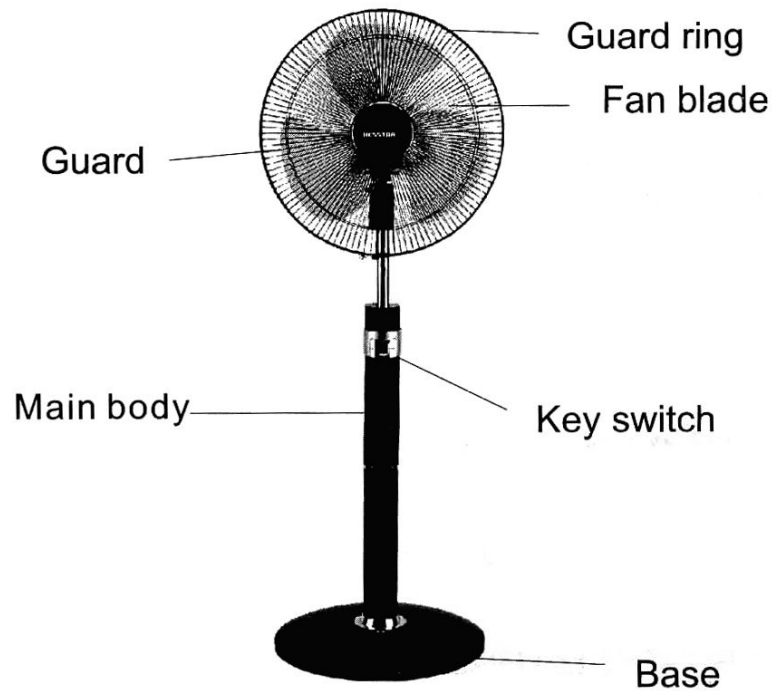

Assembly diagram

- (1) Loosen the screw from the tube and connect with the main body, then fasten the screw.
- (2) Assemble the main body into the aluminum tube then place into the small base.
- (3) Fasten the tube to the big base by the lock nut.

* This product's warranty is void if used commercially.

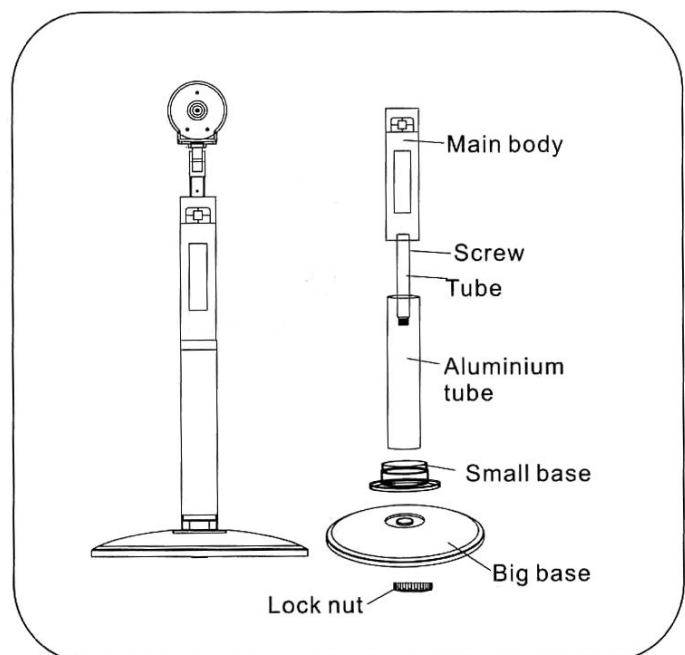

Operation way

- ✿ Place the well assembled fan on a flat surface before plugging into the socket.

- Soft touch only is need to adjust the grill to the desirde fan angle.

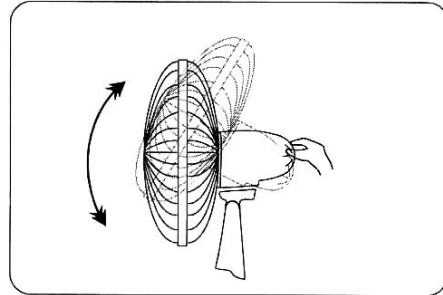

* Control panel function

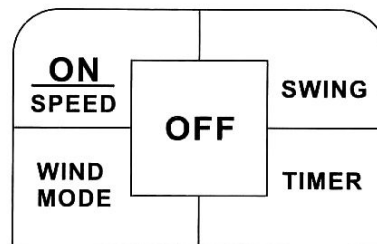
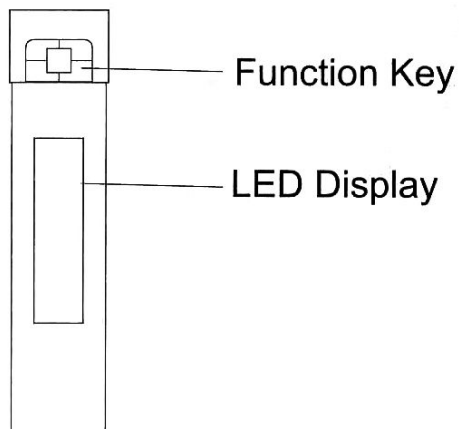

Function Key

● Use Function Key to Control

1. Speed key-This key starts to turn on the fan. Press repeatedly for speed low (1), medium(2), high(3).
2. Timer key-Press repeatedly from 0.5 hour to 7.5 hours
3. Swing key Press repeatedly to swing Left & Right(1), Up & Down(2), figure "8"(3) and off(4)
4. Off key- Turn off the fan.

● Remote controller function

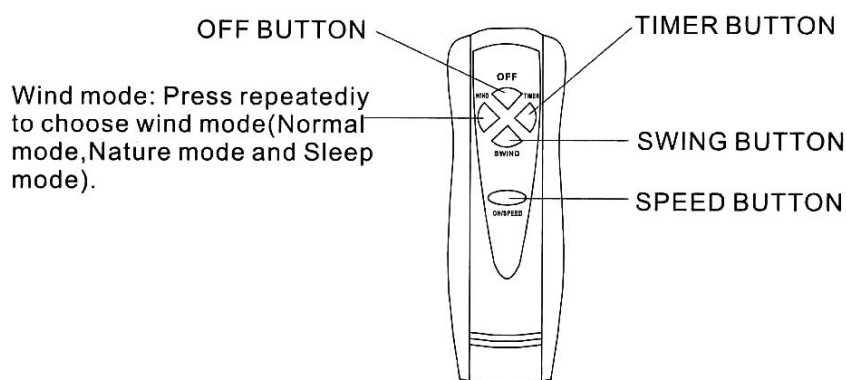

Oscillation

1. ONCE: LEFT-RIGHT OSCILLATION

2. TWICE: UP-DOWN OSCILLATION

3. THIRD: "8" OSCILLATION

4. FOURTH: STOP OSCILLATION

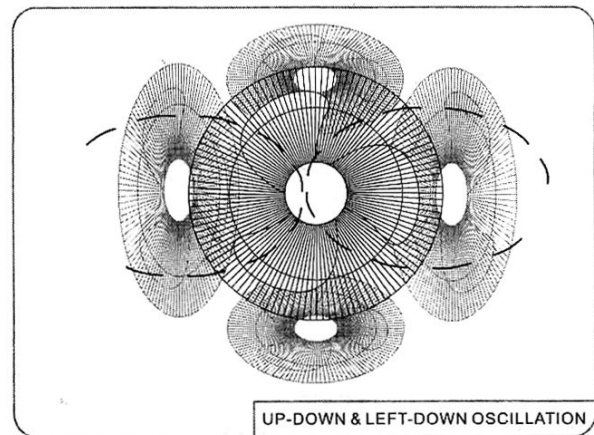
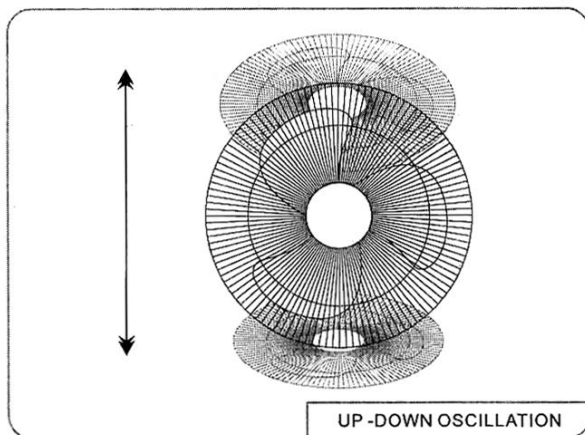
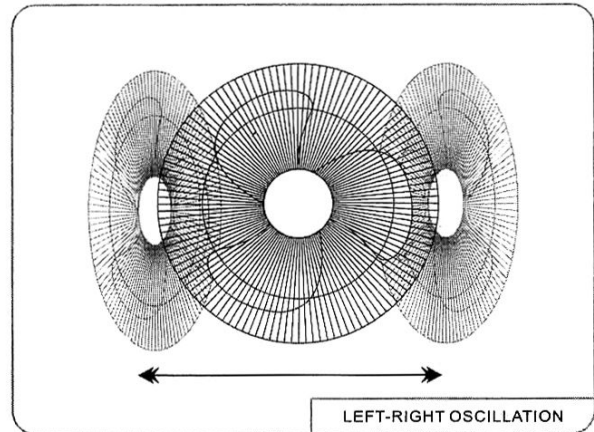
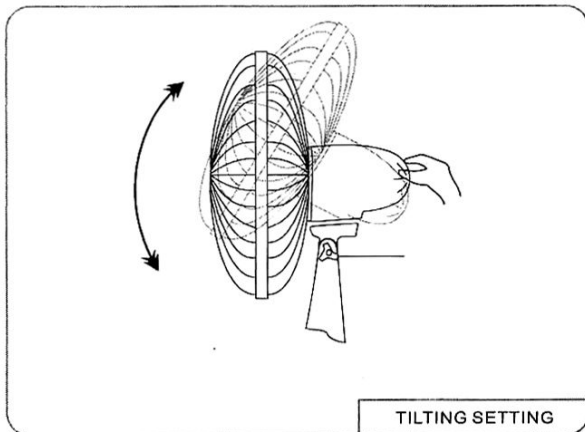

MODEL	HF-816RS
RATED VOLT	230-240V~ /50Hz
RATED POWER	55W
COLOR	BLACK

Notes

Never insert fingers into the guard when the fan is running.

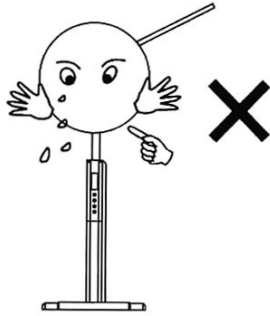

Please keep a certain distance between the children and the fan.

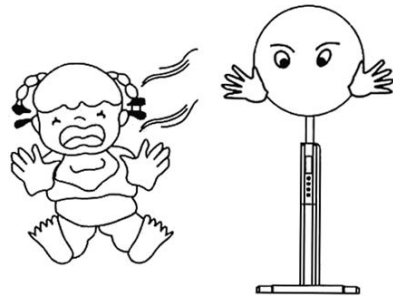

Do not use the fan near water or fire otherwise it may cause electrical hazard.

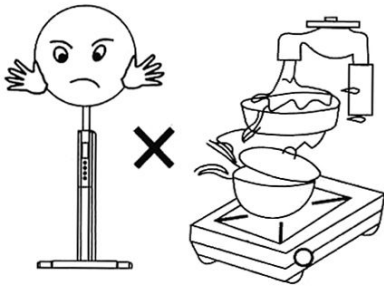

Don't use the fan too near window because the curtain may be sucked into the fan which will lead to electrical hazard

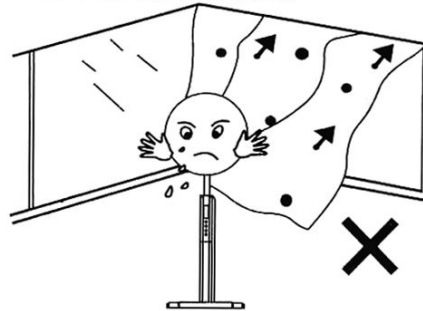

Don't make the fan blowing straightly toward the acid, oil and other chemical substances.



Be sure the fan is on a stable surface when operating to avoid overturning Before using the fan.

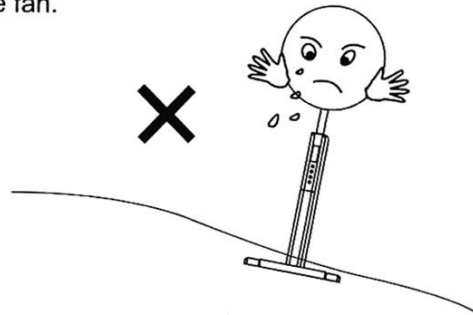

Please check whether the voltage used is in line with the voltage on the label of the fan or not.



Turn off the power before pulling the plug out.

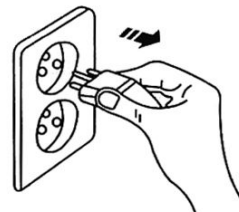

- 1) This appliance is not intended for use by persons (including children) with reduced physical, sensory or mental capabilities, or lack of experience and knowledge, unless they have been given supervision or instruction concerning use of the appliance by a person responsible for their safety
- 2) Children should be supervised to ensure that they do not play with the appliance.
- 3) If the supply cord is damaged, it must be replaced by the manufacturer, its service agent or similarly qualified persons in order to avoid a hazard